

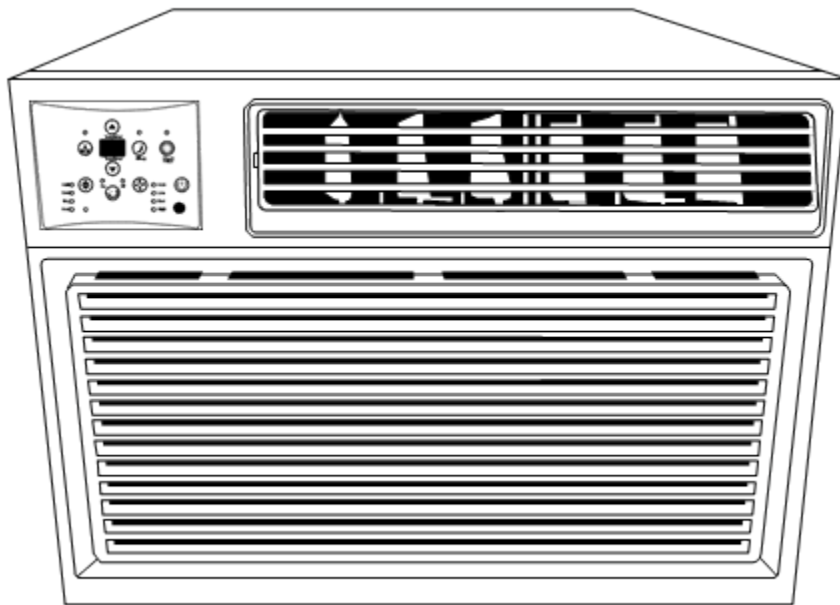

# Window Air Conditioner with Supplemental Heater



## **WAC8001W / WAC12001W**

### Owner's Manual

*For more information on other great EdgeStar products on the web, go to <http://www.edgestar.com>  
To use the EdgeStar self-diagnostic tool, go to <https://support.edgestar.com>*

# Important Safety Information



**Warning:** The water produced by the window AC is not potable or suitable for drinking.  
**Do not** drink the water drained from the unit as it contains contaminants and could make you sick.

Improper handling can cause serious damage to the appliance and/or to the user. Please read the following safety information.

## **Electrical Safety**

- Make sure your hands are dry and not wet before operating the unit.
- Do not wet the front housing or control panel.
- Do not directly spray water on this Air Conditioner.
- Do not pull the unit by the cord.
- Always turn the unit off and unplug it from the socket when cleaning.
- Unplug the unit if it is not going to be used for a long period of time.
- Do not operate the unit with a damaged or loose plug and / or socket.
- Use only the correct power supply with appropriate amperage.
- If the power cord is damaged, it must be replaced by the manufacturer, a service agent, or qualified technician.
- Do not turn the unit off or on by inserting or pulling the power plug.
- Do not modify the power cord length or share the outlet with another appliance.
- Do not use this unit with an extension cord and/or adapter plug.
- Do not use this unit near flammable gases/combustibles or in close proximity to heating appliances.
- During operation do not remove any part of the outside casing.

## **General Safety**

- Do not let people or pets sit or set an object directly in front of air flow.
- If a strange sound, smell, or smoke comes from the unit, turn it off and review the troubleshooting page of this manual.
- Stop operation and unplug unit in the event of a severe storm.
- To ensure proper air flow and intake, make sure the air vents are not obstructed.
- See instructions for cleaning air filters and how often cleaning should occur.
- Do not use strong detergents when cleaning.
- Children should be supervised when operating this unit.
- Do not allow children to play with the controls or drop any objects into the air outlets or vents.
- Do not place objects or let any person sit on top of the unit.
- Route the power cord carefully to avoid a tripping hazard.
- This unit is intended for domestic home use only. Do not use the window air conditioner for commercial or industrial use. Any other use may invalidate the warranty.
- Use caution when unpacking and installing the unit as there may be some sharp edges.

# Operation of Safety Plug



Note: Electrical products should not be disposed of with household waste. Please contact your local recycling center for more information on how to recycle electronic waste.



Your window air conditioner is supplied with a Leakage-Current Detection and Interruption (LCDI) safety plug. This device provides protection to reduce the risk of fire due to arcing faults in the power supply cord. Before using your window air conditioner, follow the instructions below to ensure that the LCDI plug is working properly:

1. Plug the power cord into a grounded outlet.
2. Press the TEST button on the LCDI plug. This should trip the plug and cut the power to the air conditioner. If the plug does not trip and you are able to turn on the unit, please contact EdgeStar support.

**DO NOT USE YOUR WINDOW AIR CONDITIONER IF THE TEST FAILS.**

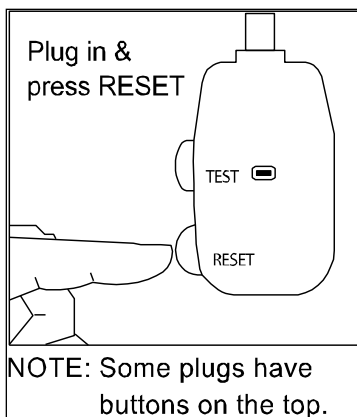

3. Press the RESET button to start using your air conditioner.



## Notes:

- Always make sure the “Reset” button is pushed in for proper operation.
- The power supply cord with LCDI plug must be replaced if it fails to reset.
- Do not use the TEST and RESET buttons as an ON/OFF switch.

# Table of Contents

<b>IMPORTANT SAFETY INFORMATION</b> .....	<b>I</b>
<b>OPERATION OF SAFETY PLUG</b> .....	<b>II</b>
<b>TABLE OF CONTENTS</b> .....	<b>III</b>
<b>INTRODUCTION</b> .....	<b>1</b>
<b>PARTS IDENTIFICATION</b> .....	<b>2</b>
SIDE VIEW.....	2
FRONT VIEW.....	2
<b>PREPARATIONS FOR INSTALLATION</b> .....	<b>3</b>
PARTS SUPPLIED.....	3
<b>WINDOW INSTALLATION INSTRUCTIONS</b> .....	<b>4</b>
PREPARING THE UNIT FOR WINDOW INSTALLATION .....	4
<i>Remove the Air Conditioner Unit from Cabinet</i> .....	4
<i>Attaching the Top Channel and Side curtains</i> .....	4
<i>Attaching Foam Adhesive</i> .....	5
INSTALLING CABINET INTO WINDOW.....	6
ATTACH SIDE CURTAINS TO WINDOW FRAME .....	7
<b>COMPLETING INSTALLATION</b> .....	<b>8</b>
<b>CONTROL PANEL OPERATIONS</b> .....	<b>9</b>
USING THE CONTROL PANEL.....	9
<i>To Turn Unit on</i> .....	9
<i>To Change Temperature</i> .....	9
<i>To Adjust Fan Speeds</i> .....	9
<i>To Select Operating Mode</i> .....	10
<i>To Operate in Auto Mode</i> .....	10
<i>To Operate in Fan Only Mode</i> .....	10
<i>To Operate in Dry Mode</i> .....	10
<i>To Use the Energy Saver Feature</i> .....	10
<i>To Use the Sleep Feature</i> .....	11
<i>To Use the Timer (Auto Start/Stop) Feature</i> .....	11
<i>To Use the Check Filter Feature</i> .....	11
<i>Digital Display</i> .....	11
<i>Error Codes</i> .....	11
<b>AIR DIRECTIONAL LOUVERS</b> .....	<b>12</b>
<b>ADDITIONAL TIPS</b> .....	<b>12</b>
<b>REMOTE OPERATIONS</b> .....	<b>13</b>
<b>MAINTENANCE</b> .....	<b>14</b>
AIR FILTER CLEANING.....	14
CABINET CLEANING.....	15
<b>NORMAL SOUNDS</b> .....	<b>15</b>
<b>ENERGY SAVING GUIDE</b> .....	<b>15</b>
<b>TROUBLESHOOTING</b> .....	<b>16</b>
<b>SPECIFICATIONS</b> .....	<b>18</b>
<b>EDGE STAR LIMITED WARRANTY</b> .....	<b>19</b>

# Introduction

Thank you for purchasing this Koldfront by EdgeStar window air conditioner. We hope that this purchase will be the beginning of a lasting and rewarding relationship between you and EdgeStar. We will provide the customer support and exemplary products necessary to nurture that relationship.

This manual contains important information regarding the proper installation, use, and maintenance of your window air conditioner. Following this manual will ensure that your product will work at its peak performance, efficiency, and safety.

Please save the original product packaging in case you need to safely transport your window air conditioner.

## For Your Records:

Please write down the model number and serial number below for future reference. Both numbers are located on the ratings label on the back of your unit and are needed to obtain warranty service. You may also want to staple your receipt to this manual as it is the proof of your purchase, and is also needed for service under your warranty.

Model Number: \_\_\_\_\_

Serial Number: \_\_\_\_\_

Date of Purchase: \_\_\_\_\_

For a more efficient experience, please do the following before contacting customer service:

- If you received a damaged product, immediately contact the dealer that sold you the product.
- Read and follow this instruction manual carefully to help you install, use and maintain your window air conditioner.
- Read the troubleshooting section of this manual as it will help you diagnose and solve common issues.
- Visit us on the web at <http://www.edgestar.com> for product guides, additional troubleshooting resources and up-to-date information. You can also find an interactive self-diagnostic tool at <https://support.edgestar.com>. If you need service, our friendly customer service representatives are available via email at [service@edgestar.com](mailto:service@edgestar.com) or by telephone at **1 (866) 319-5473**.

# Parts Identification



**CAUTION:** Make sure the drain plug is firmly installed before using the unit to prevent leaking.

## Side View

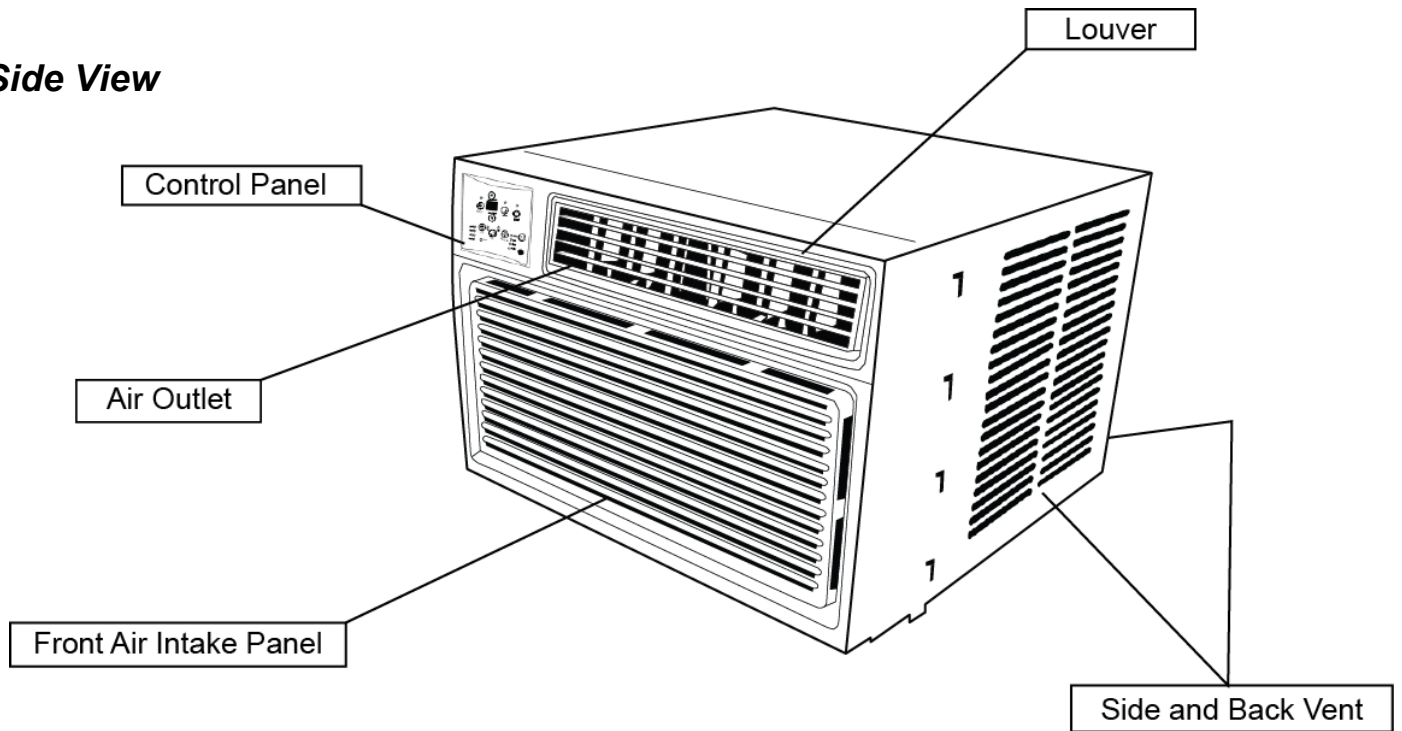

## Front View

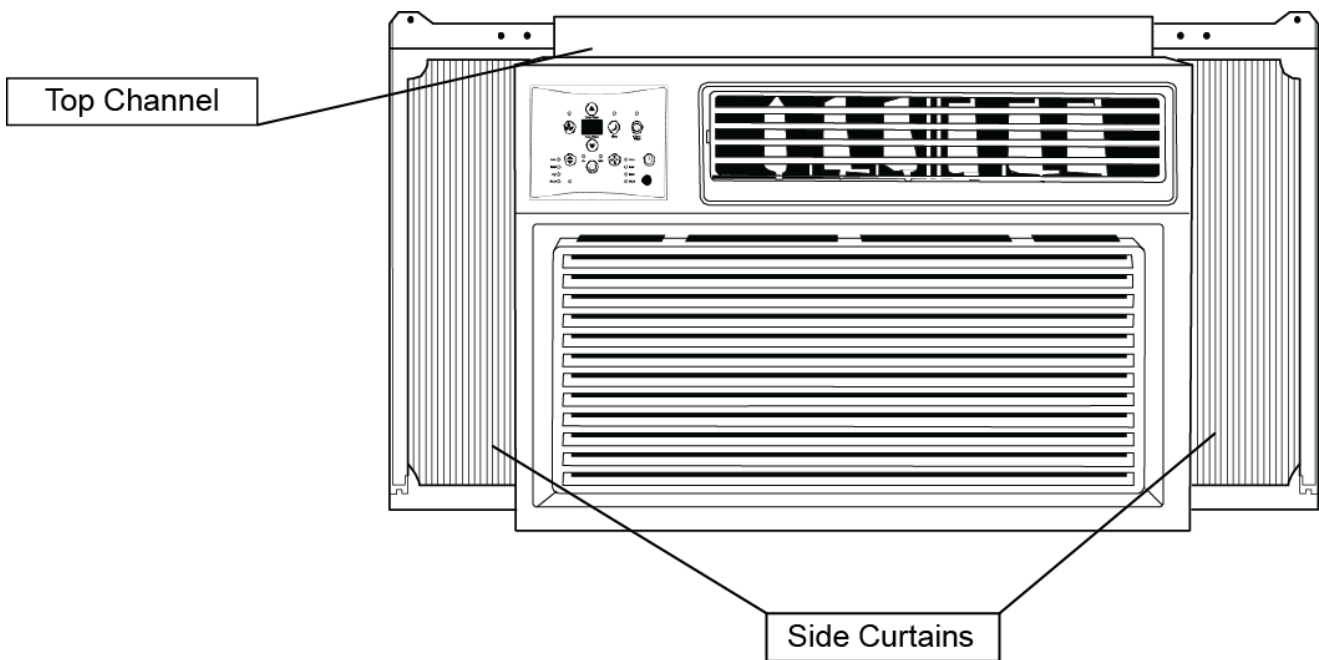

# Preparations for Installation



**Note:** You may need to contact your electrician if your room's circuit is not able to power your unit.



**Note:** To avoid risk of injury and/or product/property damage, please take the following precautions:

- Two or more people are needed to properly handle and install.
- Use proper lifting and carrying techniques.
- Before installation, make sure to inspect the window and sill to ensure they are able to handle the weight and size of this unit.
- Wearing protective gloves will help to avoid injury from sharp edges.

Before you begin, make sure you have all the parts necessary for installation.

If you have multiple windows, choose one that is near an electrical outlet that will be able to provide sufficient power to your unit. See the power requirements listed on the product label printed on the side or the back of your window air conditioner.

The following measurements are required to properly install the air conditioner.

- Window Width: 26 7/8" to 36"

## **Tools Needed:**

• Flat Screwdriver • Phillips Screwdriver • Tape Measure • Level • Drill

## **Parts Supplied:**



(3) #10 x 1/2" Phillip Screws

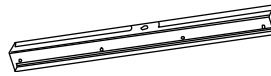

(1) Top Channel



(7) #10 x 1/2" Flat Screws



(1) Window Sash Seal



(5) #10 x 1/4" Phillip Screws



(1) Foam Seal

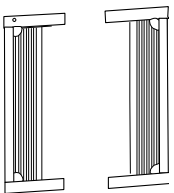

(1) Set of Side Curtains

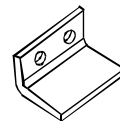

(1) Window Lock Bracket

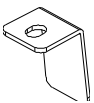

(2) Safety Lock (only vinyl windows)



(5) Weather Seals

# Window Installation Instructions



**Note:** When choosing your window make sure power supply cord is within 4 feet of a grounded 3-prong outlet.

## Preparing the unit for Window Installation

### Remove the Air Conditioner Unit from Cabinet

1. Remove the air conditioner from the carton and place on cardboard.
2. Remove 1 shipping screw from each side. (Figure 1)
3. Remove front panel by removing 1 Phillips screw from each side of the front panel. Set screws aside and save. (Figure 2)
4. Pull on the handles to slide the air conditioner out of the cabinet. Place the air conditioner on cardboard. (Figure 3)

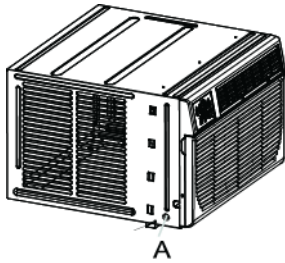

Figure 1

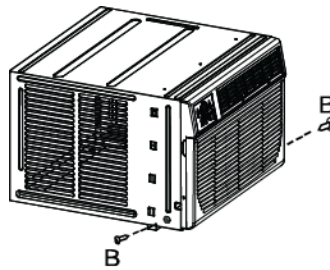

Figure 2

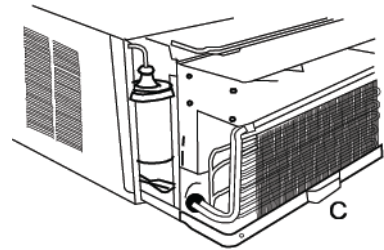
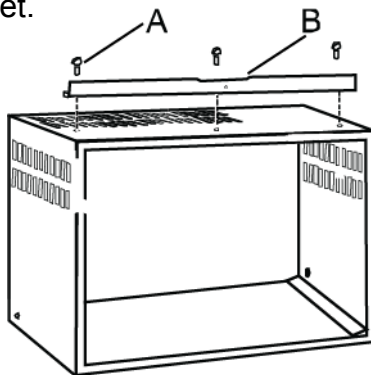

Figure 3

### Attaching the Top Channel and Side curtains

Make sure to attach the top channel and side curtains prior to installing the cabinet into the window.

1. Locate the provided bag of screws.
2. Place the top channel on top of the air conditioner cabinet, lining up the three holes in the top channel with the three holes on top of the cabinet.
3. Using the indicated screws in the figure below attach the top channel to the air conditioner cabinet.



A. # 10 x 1/4" Phillips Screw  
B. Top Channel



- To attach the side curtains to the air conditioner, insert the right-hand curtain connector tab into the curtain housing channels on the air conditioner.

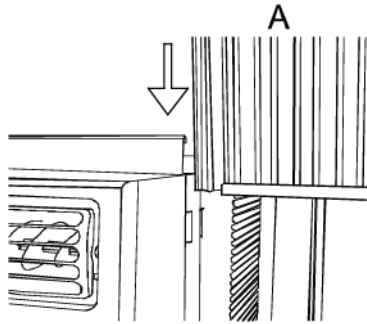

A. Side Curtain

- Insert the top of the right-hand curtain housing into the top curtain channel as shown below:

Top View:

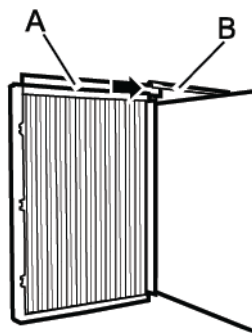

A. Curtain Housing  
B. Curtain top channel on air conditioner

- Then insert the bottom of the side curtain housing into the bottom channel on the air conditioner as shown below:

Bottom View:

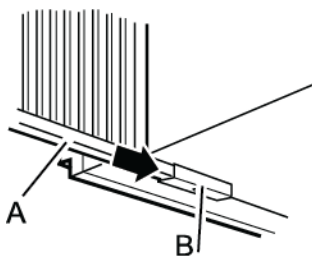

A. Curtain Housing  
B. Curtain bottom channel on air conditioner

### Attaching Foam Adhesive

- Attach the foam adhesive seal along the bottom of the curtain channel to maximize performance and efficiency.

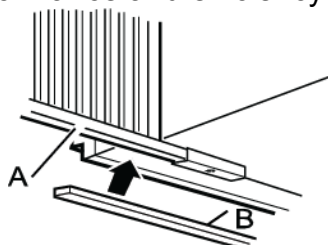

A. Curtain Housing  
B. Foam Adhesive Seal

## Installing Cabinet into Window



**Note:** When choosing your window make sure the power supply cord is within 4 feet of a grounded 3-prong outlet.

Follow the steps listed below to install the cabinet into the window.

1. Center empty cabinet into window:

- Check that lower rail of air conditioner cabinet is behind and against back side of window sill.
- Maintain a firm hold on the cabinet and lower window sash to hold the cabinet in place.
- Measure the distance of the right side and left and adjust until equal distance.

2. There are different methods to secure the cabinet into window depending on the type of window.

• For Wooden Frames:

- Use a 3/16" drill bit to drill three starter holes 3/8" deep through the three holes in the cabinet and into the window sill.
- Drill one starter hole 3/8" deep through the hole in the middle of the top rail and into the window frame.

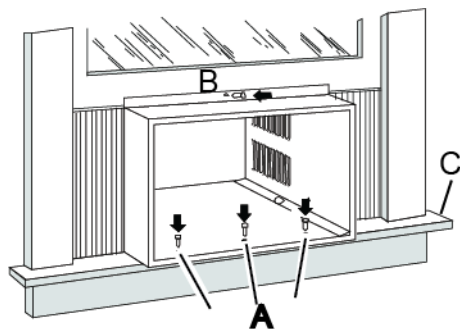

A. #10 x 1/2" Phillips  
Screws  
B. #10 x 3/4" Flat  
Screws  
C. Window Sill

• For Vinyl Windows:

- Use a 1/8" drill bit to drill one hole through the hole in the middle of the top rail into the window frame. Attach the cabinet to the window with one #10 x 3/4" Phillips screw (B in figure above).
- Place two safety locks into the holes that are located at the bottom of the cabinet and drive two locking screws through the safety locks into the cabinet as shown below:

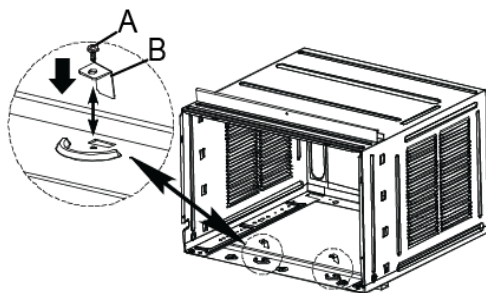

A. #10 x 3/4" Phillips  
Screw  
B. Safety Locks (Only  
for Vinyl Windows)

3. Check that the air conditioner cabinet is tilted back about  $1\frac{1}{8}$ " to  $1\frac{1}{2}$ ", which should be about 3-4 degrees downward to the outside. After proper installation, condensation should not drain from the overflow drain hole during normal use, correct slope or otherwise.

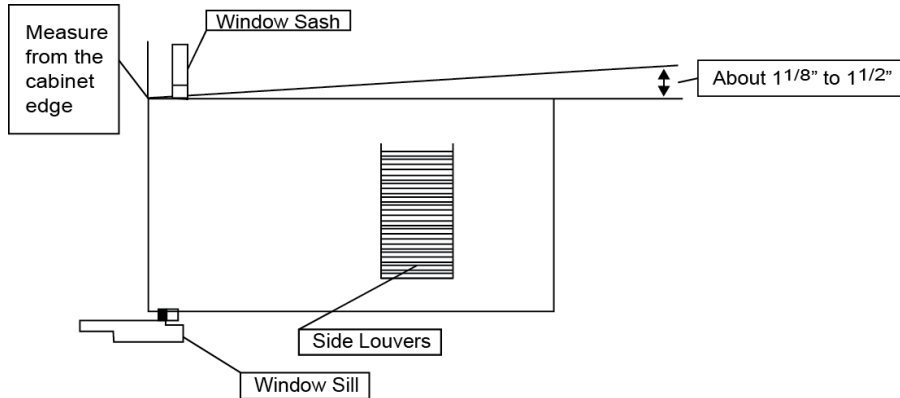

### **Attach Side Curtains to Window Frame**

1. Extend the side curtains out against the window frame.
2. Drill holes and drive locking screws:
  - Wooden Windows - Use a  $\frac{3}{32}$ " drill bit to drill four starter holes through the holes in the side curtains into the window. Screw in four #10 x  $\frac{3}{4}$ " screws through the holes in the side curtains into the window sill.

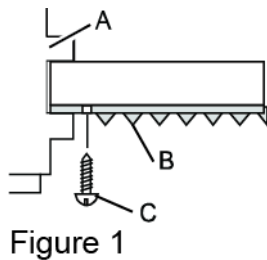

Figure 1

A. Window Channel  
B. Left-hand curtain  
C. #10 x  $\frac{3}{4}$ " Flat Screw

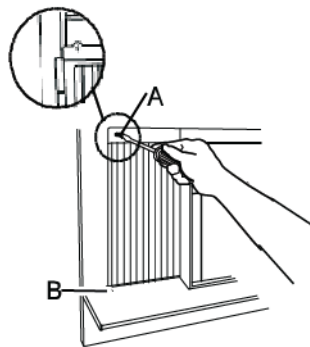

Figure 2

A. #10 x  $\frac{3}{4}$ " Flat Screw  
B. Slotted hole in the bottom of the curtain

- Vinyl Windows - Use a  $\frac{1}{8}$ " drill bit to drill two holes through the holes in the side curtains into the window frame. Screw in the #10 x  $\frac{3}{4}$ " Flat Screw through the holes in the side curtains into the window sash. Refer to figure 1 above.

4. Trim the weather seal with a proper length peel off protective backing and plug any gaps if needed as shown in Figure 2.

## Completing Installation

1. Insert the window sash seal (C) behind the top of the lower window sash and against the glass of the upper window (B).
2. Place the window-lock bracket (A) on top of lower window and against upper window sash on right side of the window.
3. Use a 3/32" drill bit to drill starter holes through the holes in the bracket (A) into the window sash.
4. Attach the window lock-bracket (A) to the window sash with two #10 x 3/4" flat screws (D) to secure the window in place.

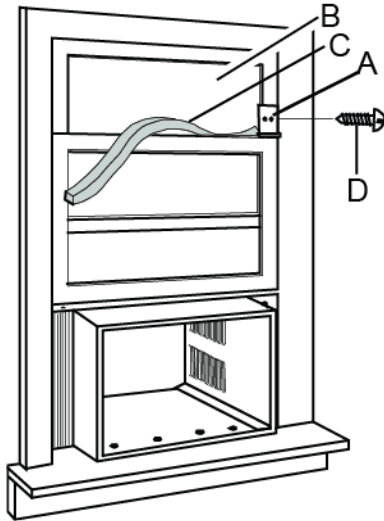

- |                           |
|---------------------------|
| A. Window Lock Bracket    |
| B. Upper Window Glass     |
| C. Window Sash Seal       |
| D. #10 x 3/4" flat screws |



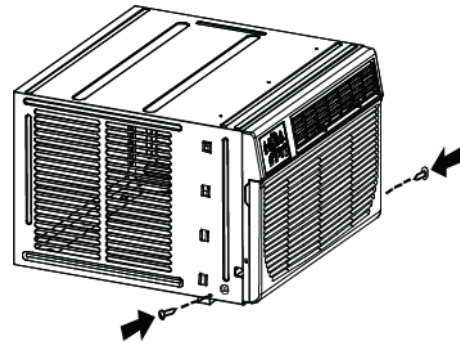
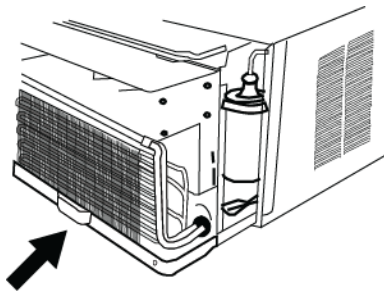





5. Insert the Air Conditioner into the cabinet.
6. Insert the front tabs of the front panel into the top of the cabinet and the window front so that they are held in place.
7. Attach the bottom front of the panel with the front panel screws.
8. Plug into a grounded 3-prong outlet.
9. Press "Reset" on the power cord supply.



10. Press the on/off button to power on the unit.

Read the Control Panel Operations section for proper use.

# Control Panel Operations

	On/Off
	Energy Saver
	Timer
	Mode
	Check Filter
	Fan Speed
	Sleep
	Temp/Timer Up
	Temp/Timer Down

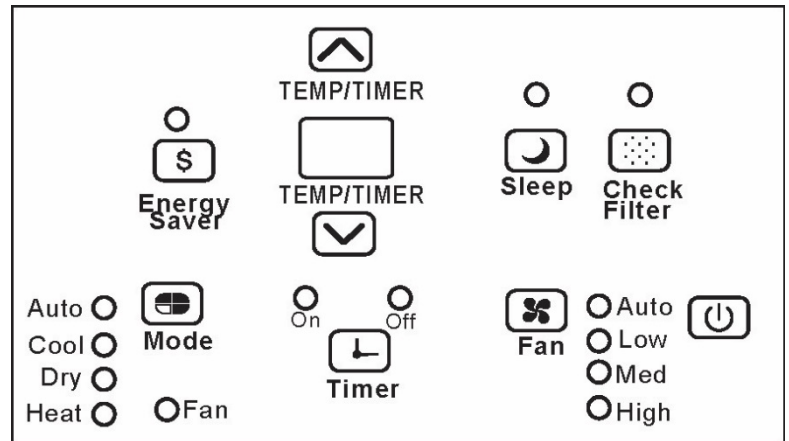

## Using the Control Panel

### To Turn Unit on:

Press the On/Off Button .



Note-The Energy Saver feature will automatically turn on in “Cool”, “Dry”, and “Auto” mode.

### To Change Temperature:

Press or hold either the Up  or Down  button until the desired temperature is seen on the digital display. This temperature will be automatically maintained anywhere between 62 °F (17°C) and 86°F (30°C). If you want the display to read the actual room temperature, see the “To Operate in Fan Only” section.

### To Adjust Fan Speeds:

To select the speed of the fan press Fan Speed  which cycles through four steps- Auto, Low, Medium, or High. Each time the button is pressed the fan speed mode is shifted.



Note-During “Dry mode” the fan speed is controlled at Low automatically.

## To Select Operating Mode:

To choose the operating mode press Mode . Each time you press this button a mode is selected in a sequence that goes from Auto, Cool, Dry, Heat, to Fan. The indicator light beside the mode button will be illuminated and remain on once the mode is selected.



**Note:** Heat function is intended to provide supplemental heating in addition to an existing heat source. The heat function has a lower BTU rating than the cool mode and therefore does not treat the same square footage. The maximum heating capacity of the unit is 15°F above the ambient room temperature.

## To Operate in Auto Mode:

AUTO Mode is a setting that allows the unit to automatically switch between COOL, FAN, and HEAT in order to achieve and maintain the desired set temperature.

- When set to “Auto” mode, the unit will automatically select cooling, heating, or fan only operation depending on the temperature selected and the current room temperature.
- Once the temperature you selected is achieved the unit will automatically maintain the room temperature by switching between modes as needed.
- While in AUTO Mode, the fan speed cannot be adjusted manually.
- When operating in AUTO MODE, the control panel display will NOT illuminate to indicate any change between Cool/Fan/Heat. The AUTO indicator will remain illuminated.



**Note:** The unit’s temperature sensor is located on the front of the unit near the air intake port. As such, a temperature reading taken manually on the opposite side of the room may read differently than what the unit is detecting. Please make note of this when operating your unit.

Also, the unit does not constantly take temperature readings. The unit will take a temperature reading periodically while operating in AUTO mode, or immediately upon adjustment of the desired set temperature. As such, it is important to understand that when operating in AUTO MODE the unit may not switch between Cooling, Heating, and Fan Mode at the exact moment when a temperature change occurs.

## To Operate in Fan Only Mode:

- Use this function only when cooling is not desired, such as for room circulation or to exhaust air (remember to open the vent). You can choose any speed you prefer.
- During this function the display will show the actual room temperature as in the cooling mode.
- In Fan Only mode, the temperature is not adjusted.

## To Operate in Dry Mode:

In this mode, the air conditioner will operate as a dehumidifier. Because the conditioned space is closed or sealed, some degree of cooling will continue to occur.





## To Use the Energy Saver Feature:

To start the Energy Saver, press . This feature is available on “Cool”, “Dry”, and “Auto”. The fan will continue to run for 3 minutes after the compressor shuts off. The fan then cycles on for 2 minutes at 10 minute intervals until the room temperature is above the set temperature, at which point the compressor turns back on and cooling starts.

## To Use the Sleep Feature:

To initiate, press the Sleep button . In this mode the selected temperature will increase (cooling) or decrease (heating) by 2°F (1°C) 30 minutes after the mode is selected. The temperature will then increase (cooling) or decrease (heating) by another 2°F (1°C) after an additional 30 minutes. This new temperature will be maintained for 6 hours before it returns to the originally selected temperature. This ends the Sleep mode and the unit will continue to operate as originally programmed. The Sleep Mode program can be cancelled at any time during operation by again pressing the Sleep button.

## To Use the Timer (Auto Start/Stop) Feature:

- When the unit is on or off, press the Timer button  and the “Timer On” indicator light illuminates. It indicates that the Auto Start program is initiated.
- To switch to off press the Timer button  again and the “Timer Off” indicator light illuminates. It indicates that the Auto Stop program is initiated.
- Press or hold the Up  or Down  button to change the Auto Time by ½ hour increments up to 10 hours or 1 hour increments up to 24 hours. The control will count down the time remaining until start.
- The selected time will register in five (5) seconds and the system will automatically revert back to display the previous temperature setting or room temperature when the unit is on. (Note-when the unit is off there is no display.)

## To Use the Check Filter Feature:

This feature is a reminder to clean the Air Filter for more efficient operation. The LED light will illuminate after 250 hours of operation. To reset after cleaning the filter press the Check Filter button  and the light will go off.

## Digital Display:

Displays the set temperature in “C” or “F” and the Auto-Timer settings. While on Fan only mode it shows the room temperature.

## Error Codes

### AS- Room temperature sensor error

- Unplug the unit and plug it back in.
- If the error repeats call for service.
- In Fan only mode it will display “LO” or “HI”.

### ● - Evaporator temperature sensor error

- Unplug the unit and plug it back in.
- If the error repeats, call for service.

### HS-Electric Heating sensor error

- Unplug the unit and plug it back in.
- If the error repeats, call for service.

## Air Directional Louvers:

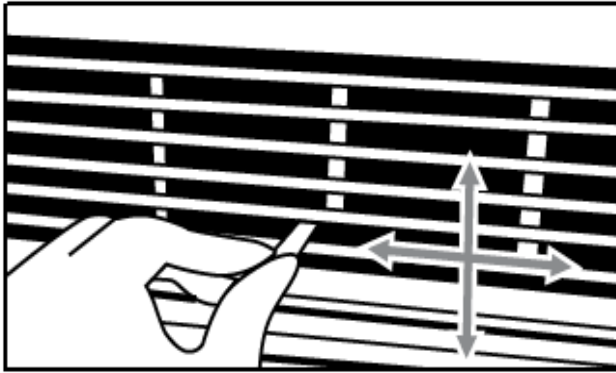

The 4-way air directional louvers allow you to direct the air flow Up, Down, Left, and Right throughout the room as needed. To adjust the air directional louvers side to side use the center handles as you move side to side.

## Additional Tips:

The “Cool” mode has an automatic 3 minute timed delay start if the unit is turned off and on quickly. This prevents overheating of the compressor and possible circuit breaker tripping. The fan will continue to run during this time.

The control is capable of displaying the temperature in degrees Fahrenheit or degrees Celsius. To convert from one to the other, press and hold the Up and Down Temp/Timer buttons at the same time for 3 seconds.



# Remote Operations

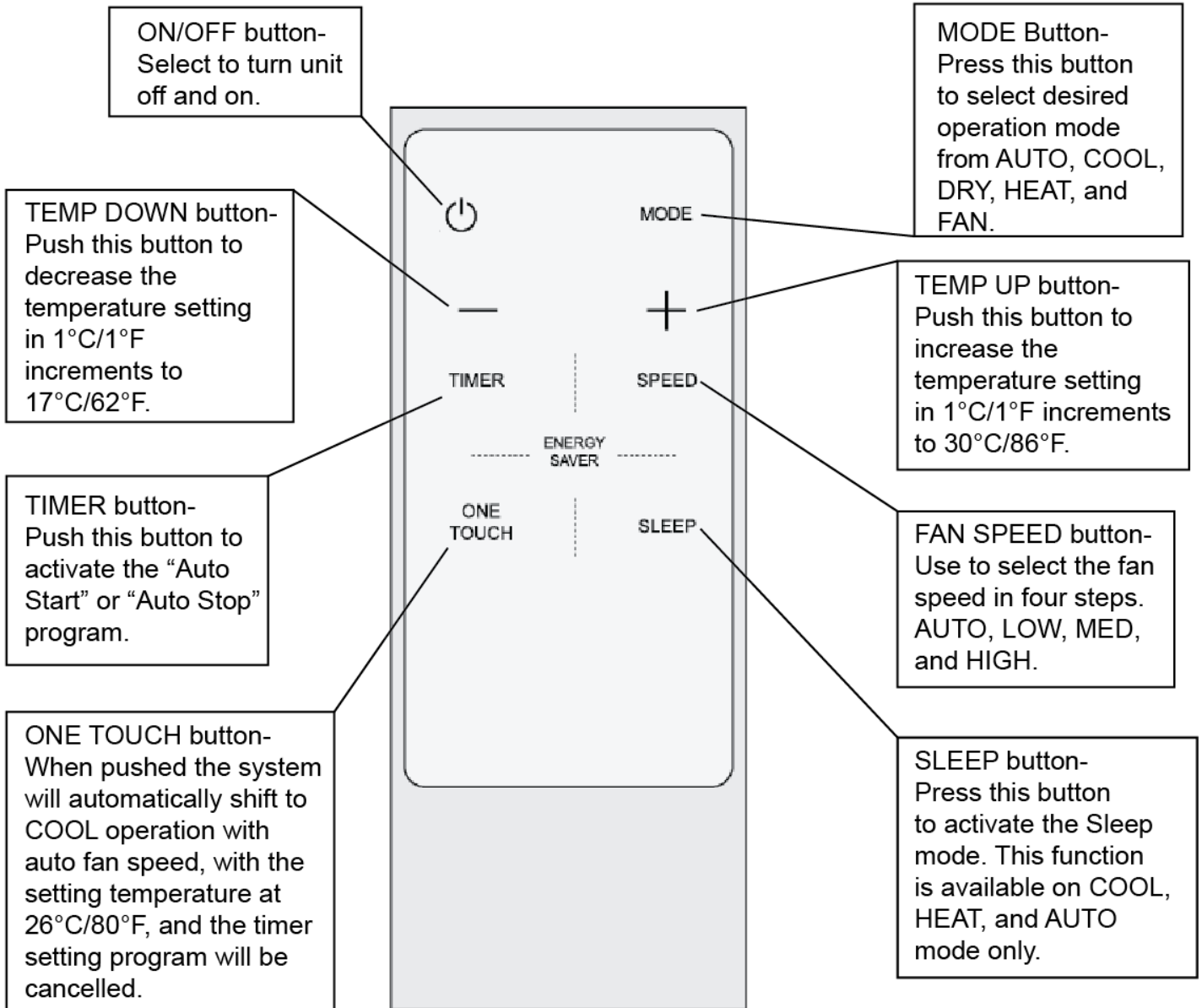

# Maintenance

Clean the air conditioner and filters regularly to maximize performance and efficiency, and prolong the unit's life. Be sure to always unplug the air conditioner from the power outlet before cleaning.

## ***Air Filter Cleaning***

The air filter should be checked at least once a month to see if cleaning is necessary. Trapped particles in the filter can build up and cause an accumulation of frost on the cooling coils.

1. Push the vent handle to the “vent closed” position.
2. Open the front panel.
3. Grasp the filter, pull up and out.
4. Wash the filter using liquid dishwashing detergent and warm water. Rinse the filter thoroughly.
5. Gently shake excess water from the filter. Be sure the filter is thoroughly dry before replacing it.
6. You also have the option of cleaning the filter with a vacuum.



**Warning:** Never use hot water over 40°C (104°F) to clean the air filter. Never attempt to operate the unit without the air filter.

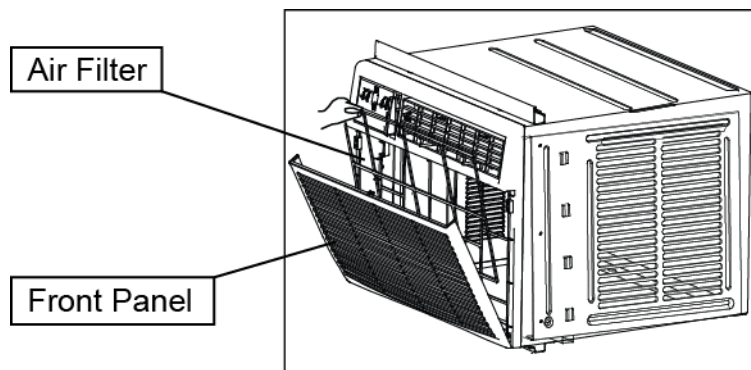

**Note:** Winter Storage- If you plan to store the air conditioner during the winter, remove it carefully from the window according to the installation instructions. Make sure to clean the unit thoroughly and cover it with plastic or return it to the original carton.

## **Cabinet Cleaning**

- Be sure to unplug the air conditioner to prevent shock or fire hazard. The cabinet and front may be dusted with an oil-free cloth or washed with a cloth dampened in a solution of warm water and mild dishwashing detergent. Rinse thoroughly and wipe dry.
- Never use harsh cleaners, wax, or polish on the cabinet front.
- Be sure to wring excess water from the cloth before wiping around the controls. Excess water in or around the controls may cause damage to the air conditioner.

## **Normal Sounds**

- High Pitched Chatter-High efficiency compressors may have a high pitched chatter during the cooling cycle.
- Sound of Rushing Air-At the front of the unit, you may hear the sound of rushing air being moved by the fan.
- Gurgle/Hiss-Gurgling or Hissing noise may be heard due to refrigerant passing through the evaporator during normal operation.
- Vibration-The unit may vibrate and make noise because of poor wall or window construction or incorrect installation.
- Pinging or Switching-Droplets of water hitting the condenser during normal operation may cause these sounds.

## **Energy Saving Guide**

Read and follow the guide below to get the best performance and efficiency from your window air conditioner:

- Do not cover the air outlet (exhaust) while in use.
- Use the timer to operate the unit before it is needed. For example, set the timer to turn on the unit in cooling mode for 3 or more hours to cool the room before you arrive. You may want to operate the unit all day if you live in a warmer climate.
- Minimize the heat sources (direct sunlight, computers, servers, people, etc.) in the room.
- Close all windows and doors.
- Use the unit in a contained room. For example, a room with four walls and a ceiling, instead of a partitioned studio, or warehouse.
- Make sure the unit is secure with no gaps where air can escape.
- Minimize the amount of humidity in the room. For example, run the unit as a dehumidifier.
- To prolong the compressor's life, please wait at least 3 minutes before turning the unit back on after shutting it off.
- Inspect and keep the air filters clean by cleaning regularly.
- Perform routine maintenance.

# Troubleshooting

Follow the troubleshooting guide below to resolve common issues.

Issue	Possible Cause	Solution
My air conditioner is not functioning at all.	The wall plug is disconnected.	Make sure the unit is plugged in.
	The LCDI power cord is tripped.	Press the Reset button on the LCDI cord.
	The house fuse is blown or the circuit breaker is tripped.	Replace the fuse with a time delay type or reset circuit breaker.
	The control panel is off.	Turn the control panel ON and set it to your desired setting.
	There is insufficient power.	Move the unit to another outlet. Check your circuit breaker. (Refer to the rating label on the back of the unit to determine the Amperage draw).
The air from the unit does not feel cold enough.	The room temperature is below 17°C (62°F).	Cooling may not occur until the room temperature rises above 17°C (62°F).
	The temperature sensing element is touching the cold coil, which is located behind the air filter.	Straighten the tube away from the coil.
	The compressor was shut-off by changing modes.	Wait approximately 3 minutes and listen for the compressor to restart when it is set in the COOL mode.
The air conditioner is cooling but the room is too warm. Ice is forming on the cooling coil behind the decorative front.	The outdoor temperature is below 18°C (64°F).	To defrost the coil, set the unit to FAN ONLY mode.
	The air filter may be dirty.	Clean the filter. Refer to the maintenance section. To defrost set the unit to FAN ONLY mode.
	The thermostat is set too cold for night-time cooling.	To defrost the coil, set the unit to FAN ONLY mode. Then, set the temperature to a higher setting.
The air conditioner is cooling but the room is too warm. NO ice is forming on the cooling coil behind the decorative front.	The air filter is dirty and the air is restricted.	Clean the air filter. Refer to the Maintenance section.
	The temperature is set too high.	Set the temperature to a lower setting.

<b>Issue</b>	<b>Possible Cause</b>	<b>Solution</b>
The air conditioner is cooling but the room is too warm. NO ice is forming on the cooling coil behind the decorative front.	The air directional louvers are positioned improperly.	Reposition the louvers for better air distribution.
	The front of the unit is blocked by drapes, blinds, furniture, etc. that restrict air distribution.	Clear any blockage in front of the unit.
	There are open doors, windows, etc.	When entrances are open cold air escapes. Close all doors, windows, etc.
	The unit was recently turned on in a hot room.	Allow additional time to remove "stored heat" from the walls, ceiling, floor, and furniture.
The air conditioner turns on and off rapidly.	The air filter is dirty and the air is restricted.	Clean the air filter.
	The outside temperature is extremely hot.	Set the FAN speed to a higher setting to bring air past the cooling coils more frequently.
There is noise when the unit is cooling.	Some air movement sound is normal.	If the unit is too loud, set it to a slower FAN setting.
	There is window vibration due to poor installation.	Refer to the installation instructions or check with the installer.
There is water dripping INSIDE when the unit is cooling.	The unit was improperly installed.	Tilt the air conditioner slightly to the outside to allow water drainage.
There is water dripping OUTSIDE when the unit is cooling.	The unit is removing a large quantity of moisture from a humid room.	This is normal during excessively humid days.
The remote control is not sensing.	The remote control is not located within range of the unit.	Place the remote control within 20 feet and a 180 degrees radius of the front of the unit.
	The remote control signal is obstructed.	Remove the obstruction.
The room is too cold.	The temperature is set too low.	Increase the set temperature.

## Specifications

Description of Product	Window Air Conditioner with Supplemental Heater	Window Air Conditioner with Supplemental Heater
Model	WAC8001W	WAC12001W
Voltage / Frequency	115V / 60Hz	208-230V / 60Hz
BTUs (cooling / heating)	8000 / 3500	12,000 / 11,000
Current (cooling / heating)	6.3A / 11.6A	5.0A / 16.0A
Color	White	White
Coolant	R410A: 13.4 oz.	R410A: 22.22 oz.
Timer	24 Hour	24 Hour
Dimensions W x D x H	22.6" x 23" x 16.1"	22.6" x 23" x 16.1"
Weight	70.5 lbs.	88.4 lbs.

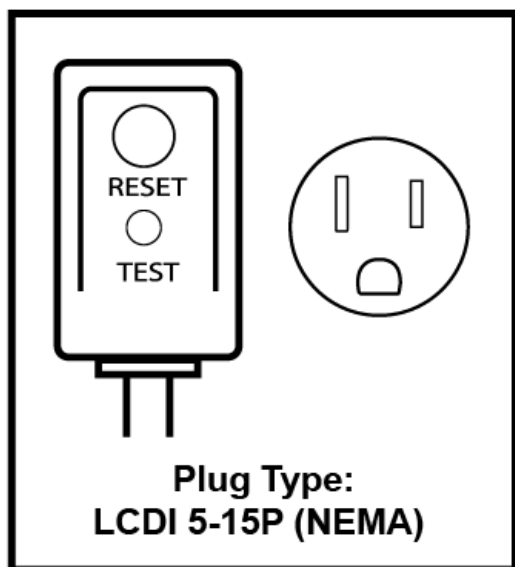

WAC8001W

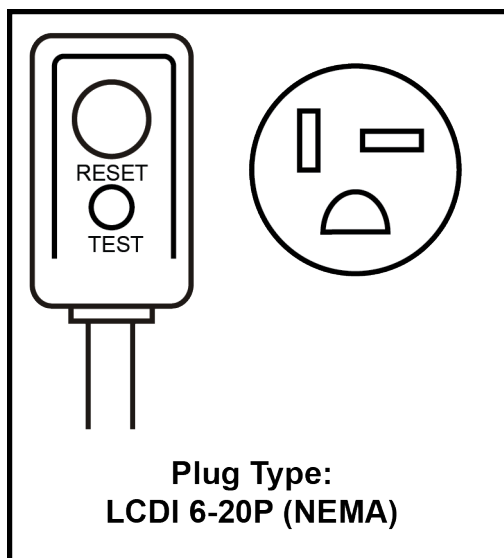

WAC12001W

# EdgeStar Limited Warranty

## Full Two-Year Parts and Labor

This product is warranted by EdgeStar and is subject to any conditions set forth as follows:

### WHAT IS COVERED:

For a period of TWO (2) YEARS from the date of original retail purchase, EdgeStar will repair or replace any part free of charge, including labor, that fails due to a defect in materials or workmanship. Labor will be performed free of charge at an authorized EdgeStar repair facility and EdgeStar will supply new, rebuilt, or refurbished parts free of charge. EdgeStar may request a defective part be returned in exchange for the replacement part. All replacement parts or products will be new, remanufactured, or refurbished. All products and parts replaced by EdgeStar under warranty service become the property of EdgeStar. After the 24 month period, EdgeStar will no longer be responsible for labor charges incurred or replacement parts. All defective products and parts covered by this warranty will be repaired or replaced on a mail-in basis to an EdgeStar authorized repair facility.

This warranty applies to the original purchaser only, and only covers defects in workmanship experienced during operation of the product under normal service, maintenance, and usage conditions. This warranty applies to the purchase and use of this product in residential settings within the contiguous United States of America.

### Exceptions: Commercial or Rental Use Warranty

90 days labor and parts from date of original purchase. No other warranty applies.

### WHAT IS NOT COVERED - The following limitations apply to the coverage of this warranty. This warranty does not cover:

- Labor charges for installation, setup, or training to use the product.
- Shipping damage, and any damage caused by improper packaging for shipment to an authorized service center, and any damaged caused by improper voltage or any other misuse, including abnormal service, handling, or usage.
- Cosmetic damage such as scratches and dents.
- Normal wear and tear on parts or replacement of parts designed to be replaced, e.g. filters, cartridges, batteries.
- Service trips to deliver, pick-up, or repair; install the product; or to instruct in proper usage of the product.
- Damages or operating problems resulting from misuse, abuse, operation outside environmental specifications, uses contrary to instructions provided in the owner's manual, accidents, acts of God, vermin, fire, flood, improper installation, unauthorized service, maintenance negligence, unauthorized installation or modification, or commercial use.
- Labor, service, transportation, and shipping charges for the removal and replacement of defective parts, beyond the initial 24 month period.
- Products that have been modified to perform outside of specifications without the prior written permission of EdgeStar.
- Products lost in shipment, or theft.
- Products sold AS IS or from an unauthorized reseller.
- Products with serial numbers that have been removed, defaced, or invalidated.
- Damage from other than normal use.
- Replacement or repair of household fuses, circuit breakers, wiring, or plumbing.
- Damage to personal property from use of product.
- Damage from service other than from an authorized EdgeStar repair facility.
- Hoses, knobs, lint trays and all attachments, accessories, and disposable parts.
- Any service charges not specifically identified as normal such as normal service area or hours.
- Any special or consequential damages arising out of the use of the product.

**OBTAINING WARRANTY SERVICE:** If you believe your product is defective, contact EdgeStar Customer Support for troubleshooting assistance and warranty service at [www.edgestar.com](http://www.edgestar.com) or call 1-866-319-5473. Before contacting Customer Support you are required to have your model number, serial number, and proof of purchase available upon request. Once an EdgeStar authorized representative has confirmed that your product is defective and eligible for warranty service, the product must be returned to an EdgeStar authorized repair facility. EdgeStar is not responsible for damage resulting from shipper mishandling or improper packaging. Do not return a defective product to the place of purchase. Products received without a return authorization number will be refused.

THIS WARRANTY IS IN LIEU OF ANY OTHER WARRANTY, EXPRESS OR IMPLIED, INCLUDING WITHOUT LIMITATION, ANY WARRANTY OF MERCHANTABILITY OR FITNESS FOR A PARTICULAR PURPOSE. TO THE EXTENT ANY IMPLIED WARRANTY IS REQUIRED BY LAW, IT IS LIMITED IN DURATION TO THE EXPRESS WARRANTY PERIOD ABOVE. NEITHER THE MANUFACTURER NOR ITS DISTRIBUTORS SHALL BE LIABLE FOR ANY INCIDENTAL, CONSEQUENTIAL, INDIRECT, SPECIAL, OR PUNITIVE DAMAGES OF ANY NATURE, INCLUDING WITHOUT LIMITATION, LOST REVENUES OR PROFITS, OR ANY OTHER DAMAGE WHETHER BASED IN CONTRACT, TORT, OR OTHERWISE. IN NO EVENT AND UNDER NO CIRCUMSTANCE OF ANY TYPE OR KIND SHALL THE SELLER, MANUFACTURER, AND/OR DISTRIBUTOR BE LIABLE FOR ANY REASON, UNDER ANY THEORY, FOR MORE THAN THE BASIC COST OF THE PRODUCT TO THE PURCHASER OR END USER. SOME STATES DO NOT ALLOW THE EXCLUSION OF INCIDENTAL OR CONSEQUENTIAL DAMAGES, SO THE ABOVE EXCLUSION MAY NOT APPLY TO YOU. THIS WARRANTY GIVES YOU SPECIFIC LEGAL RIGHTS. YOU MAY HAVE OTHER RIGHTS THAT VARY FROM STATE TO STATE.